



Not legal for sale or use on pollution controlled vehicles

Installation and Adjustment Instructions for Summit Racing MAX-efi500 Throttle Body System P/N SUM-240500

Please read the full instructions before beginning your installation. These instructions cover the basic kit installation and setup. Failure to follow these instructions may result in malfunctioning of the

system. For technical assistance with your MAX-efi 500 System, call the Summit Racing Tech Line at (330) 630-0240 or go online to: www.summitracing.com.

Warning: Caution must be observed when installing any product involving fuel system parts. Work in a well ventilated area with an **approved fire extinguisher readily available**. Eye protection and other safety apparel should be worn to protect against debris and sprayed gasoline. We recommend having this installation performed by an experienced, qualified, automotive technician. The finished installation must be thoroughly checked for any fuel system leaks. All safety precautions must be observed when working with fuel. Disconnect the battery ground wire (-) before starting the installation.

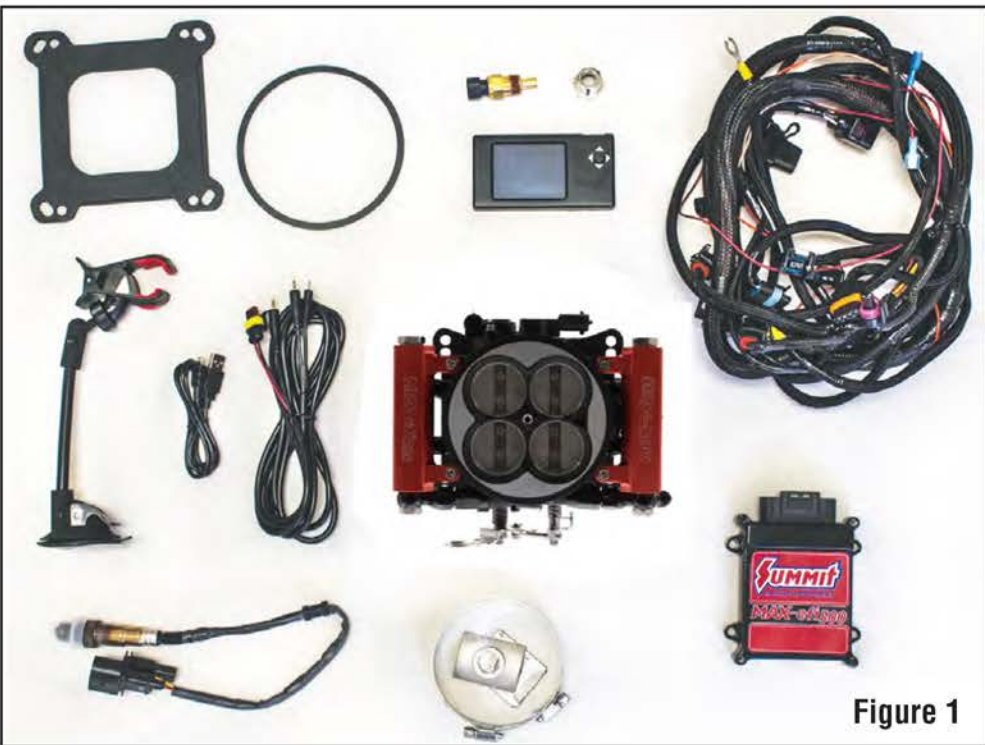

- SUM-240500 KIT CONTENTS**
- (1) 4-injector throttle body with matte black finish
 - (2) inlet/outlet port plugs (Installed on throttle body)
 - (1) Harness "A" (plug-in pigtail use harness)
 - (1) Cable for handheld controller
 - (1) ECU
 - (1) Coolant Temperature Sensor
 - (1) 1/2" NPT to 3/8" NPT Reducer
 - (4) Injectors pre-installed
 - (1) Idle Air Control (installed on throttle body)
 - (1) Throttle Position Sensor (mounted on throttle body)
 - (1) TMAP Sensor (installed on throttle body)
 - (1) Wide Band O2 Sensor
 - (1) Handheld Controller with billet case
 - (1) Dashboard mounting bracket for Controller (1) -06 AN crossover hose with -6AN male inlet fitting (installed on throttle body)
 - (1) Gasket kit

Figure 1

Table of Contents

Kit contents	1	TMAP	4	Handheld Controller	6
About your MAX-efi500 System	2	IAC	4	Initial Programming	6
Special instructions	2	TPS	4	Fan Setup	6
Engine protection feature	2	Coolant Sensor Installation	4, 5	Fuel Delivery Requirements	7
Vacuum Ports	2, 3	Injectors	5	Wiring Diagrams	
Throttle Body Installation	3	Wiring the EFI System	5	With Ready-to-Run distributor	8
Wide Band O2 Sensor Installation	3	On-Engine Adjustments	5	With HEI distributor	9
Air Leaks	4	IAC setup	5, 6	With External CDI Box	10
Installing the Harness	4	Wire Chart	6		

About your MAX-efi500 System

CONGRATULATIONS on your purchase of the Summit MAX-efi500! The MAX-efi500 System will bolt directly to any 4-BBL Intake Manifold. To fit on a spread bore 4-BBL manifold requires an inexpensive adapter plate to avoid leaks. Suitable adapter plates are available from several suppliers such as Summit Racing (SUM-G1420). Your existing distributor and, if so equipped, ignition box functions as before and controls timing. The MAX-efi500 System is self-tuning once the initial setup is performed using the hand-held controller. When the necessary initial inputs are made with the hand-held controller the MAX-efi500 System creates a base fuel map to get the engine running. Then the self-tuning programming will fine tune the map to produce optimum power and

performance. Through the use of a Wide Band O₂ Sensor the system can continuously make adjustments in the fuel delivery to provide the correct air/fuel ratio under all climate and altitude conditions. Several sensors are also integrated in the throttle body assembly including the Throttle Position Sensor (TPS), and the Temperature Manifold Absolute Pressure Sensor (TMAP). The Wide Band O₂ Sensor is installed into the exhaust pipe. This system is designed with safety in mind and has a self adjusting "limp home" mode. It also has a data logging feature to track what is going on with the system while it is running, to ensure optimal performance.

Special instructions

Make sure that you remove ALL low pressure hoses, fittings and clamps on factory fuel lines and replace them with EFI rated fuel hose. Also the use of proper flared connections and clamps is a necessity. Be careful not to mix 45° and 37° AN fittings, they look similar but will not work together. 45° fittings usually come from a hardware store or auto parts store while 37° AN fittings are the ones supplied by Summit and most speed shops.

- Cranking fuel (choke) and hard throttle hits (accelerator pump) are tuned by the user. Selecting the right "cam" and engine CID (cubic inch) during setup will get the learning closer. Cruise and wide open throttle (WOT), mixture (trims) are continuously learned and tweaked by the system.
- The MAX-efi500 needs an external fuel pressure regulator set at 58 PSI. Fuel sump reservoirs containing a high pressure pump and regulator are available. These serve as a float and are fed by a low pressure mechanical pump.

- The Summit MAX-efi500 systems are intended for use with unleaded pump gas. The system is compatible with E-85, but this requires advanced tuning knowledge. Maximum horsepower fueling capacity is reduced by approximately 30% with E-85. Fuel system components should be E-85 compatible and in new condition to prevent sludge from breaking loose.

• The Summit MAX-efi500 is designed to be used with street based ignition systems: Summit Racing® Multi-Spark Digital CD Ignition, MSD Digital 6AL, MSD Street Fire, etc. It will not operate with race oriented systems such as MSD digital 7AL, 7AL-2, 7AL-3 and 8-Plus.

• This system is NOT smog legal.

• The MAX-efi500 comes with pre-installed 66-lb flow injectors and is capable of handling up to 500 hp.

• Please refer to ignition system's instructions as some features may need to be altered for proper operations of the EFI System. The MAX-efi500 does not control timing, but depends on the ignition timing curve to be correct for optimal throttle response.

Always turn off ignition and allow at least 15 seconds for ECU to save if disconnecting battery

Very important note: Your fuel tank must have a vent to prevent pressure building up inside the tank.

Engine Protection Feature

The MAX-efi 500 System is programmed with a limp home mode. This feature does not shut down your system, instead the ECU is designed to compensate if a sensor fails. This means, that if for any reason a sensor fails, that sensor will receive either a default value or a simulated value. This is to ensure that the engine remains running in a safe and controlled manner so that you can get to a repair facility, or to your home, to resolve the issue. Due to the compensation features of the ECU, the way to check if something is going wrong with your system, is by the fault

codes option on the main menu of your hand-held controller. The fault code comes up under OBD-II, diagnostic standard, but to the right of the code it will state which sensor is having the problem. A new feature programmed into the hand-held is a rev offset. This feature will protect the engine from long term abuse because it lowers your built in rev limiter enable to prevent over revving and possible engine damage during warm up. It will automatically turn the feature off once your engine reaches operating temperature.

Determining Use of Vacuum Ports

Determine the engine's need for vacuum ports including ported and manifold vacuum. These ports cover accessories such as power brakes, vacuum advance, transmission modulator, PCV and possibly more. There are two 3/16" male nipples and three 3/8" male nipples. See figure 1 and 2 for location and use of various vacuum nipples.

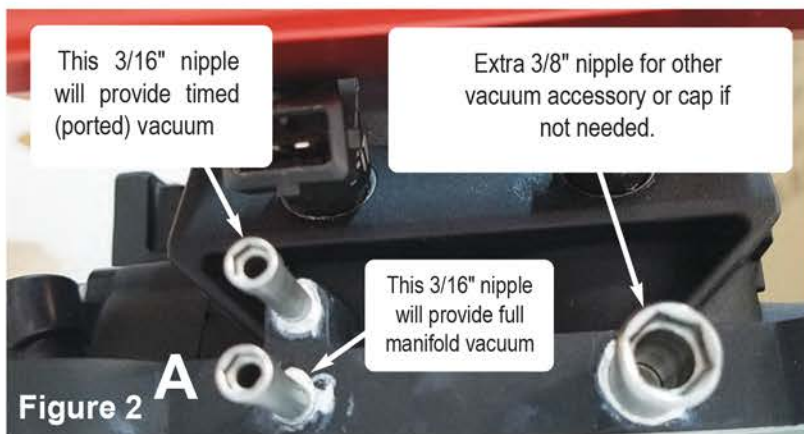

Very Important Note:
Your fuel tank MUST be vented to prevent pressure from building up inside the tank.

NOTE: An installation video and tuning video can be viewed at: www.SummitRacing.Com/Parts/SUM-240500

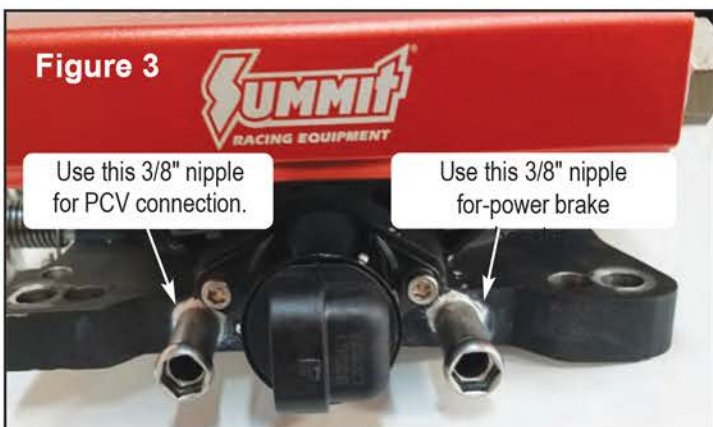

Installing the Throttle Body



1. Place the supplied gasket on the manifold (see above) and place the throttle body onto the gasket over the existing studs. The throttle body linkage must be on the driver's side of the engine.
2. Install the original nuts and washers onto the four carburetor studs. See Figure 4.
3. Tighten to 10 lb. ft. of torque in several steps using a crisscross



Installing the Wide Band Oxygen (O₂) Sensor

This is the key component of any EFI system. Only one sensor is required. This sensor continuously monitors the exhaust gas mixture and sends the information to the ECU where adjustments are constantly made to maintain the air/fuel targets.

1. The supplied O₂ Sensor Bung can be installed in either exhaust bank.
2. The Sensor connects to one of the cables in the main wiring harness. See Figure 7 on next page.
3. The ideal location for the sensor is in the exhaust collector or within 8-inches of the collector itself. It must always be at least 18-inches from the exhaust tip, to prevent reversion and false lean conditions.
4. The sensor should be between 10° to 14° above horizontal (see figure 6 below) to allow condensation to run off. If this is not adhered to, the sensor is susceptible to damage.
5. Never position the sensor on the outside of a bend in the exhaust tubing.
6. The sensor must always be mounted ahead of any catalytic converter if vehicle is so equipped.
7. Drill a 7/8" diameter hole in the desired location.

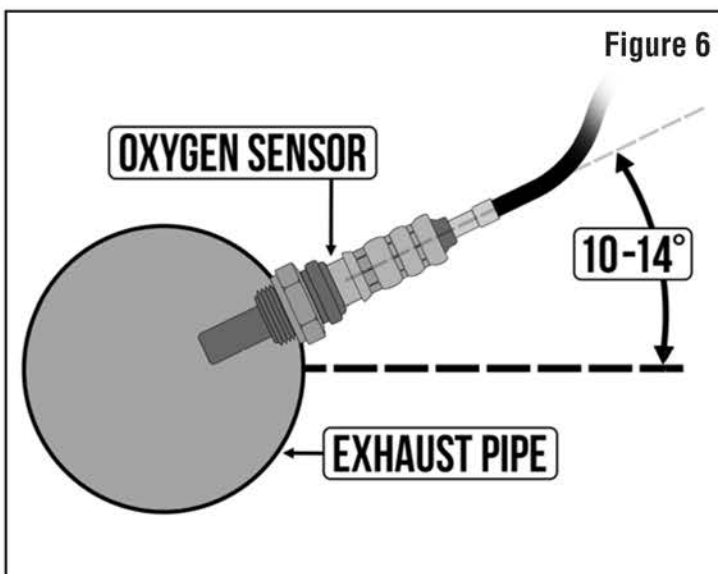

8. The supplied bung kit can either be welded in place or clamped onto the pipe. The clamp-on style works well and will not leak. If welded, make sure the bung is welded completely all the way around and does not leak. Thread an M18-1.5 bolt into the bung to prevent distortion.
9. Install the sensor into the bung. Tighten securely.
10. Connect the O₂ sensor to the sub-harness that connects to the throttle body. See Figure 7.
11. Note: The O₂ Sensor will not work on "Zoomie" style headers.

WARNING: Do not start the engine without the sensor cable connected to the throttle body and the EFI system is fully operational or damage will occur to the sensor!

AIR LEAKS: It is important that no air leaks exist anywhere in the exhaust system, before or after the sensor, as this will cause false readings. This will lead to poor engine performance, including misfires, and the inability to properly auto-tune the EFI. Continued running of the system with an exhaust leak can create detonation and possible severe

engine damage. Incorrect installation of the sensor, exhaust leaks, and any resulting damage is not covered by the Summit manufacturer's warranty. It is very important to ensure your exhaust is leak-free. For optimum EFI operation and function, your exhaust (on the sensor side) must be totally secure with no leaks.

Installing the Wiring Harness

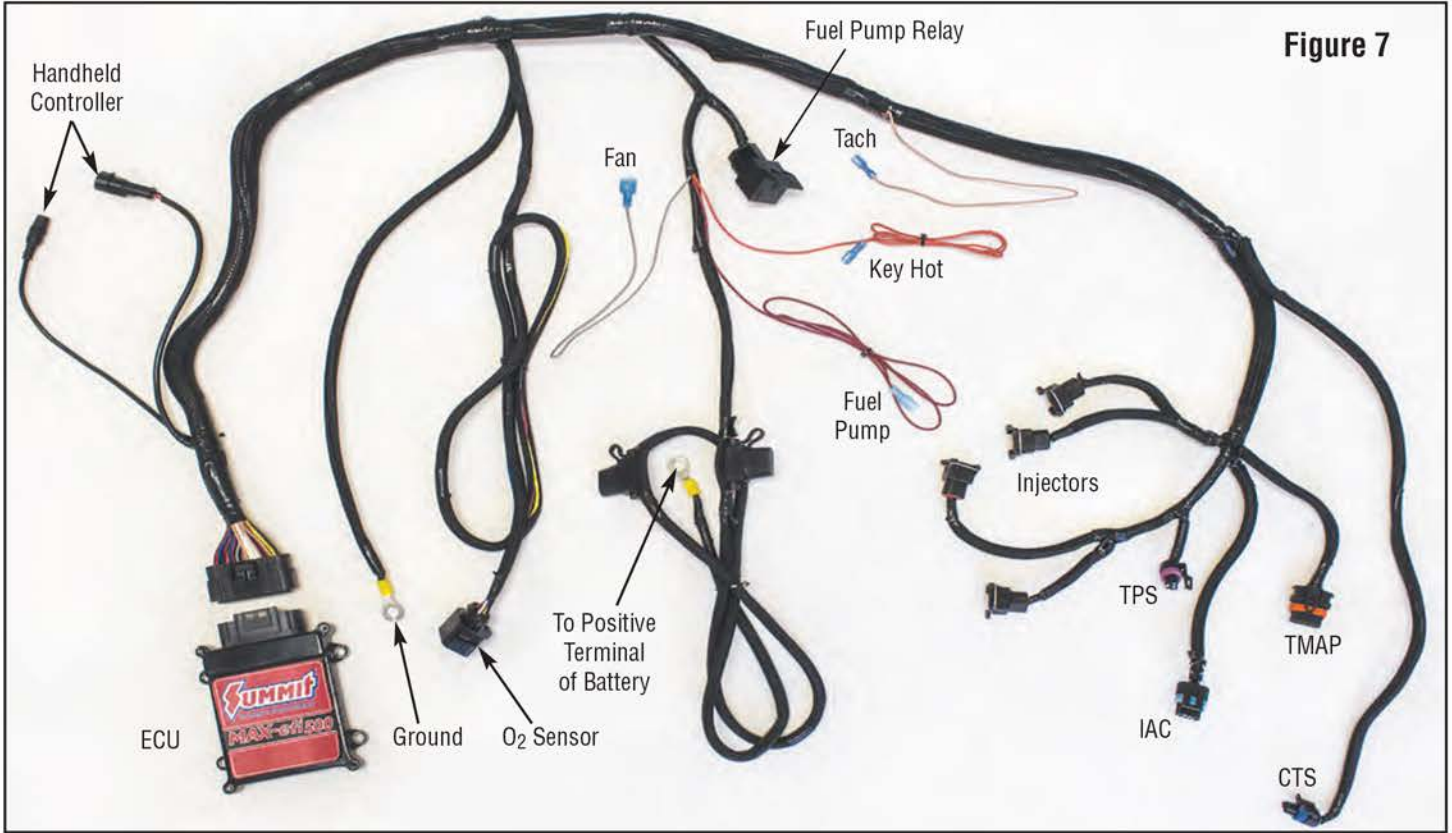

Figure 7

When installing the harness, the external ECU can be mounted anywhere in the engine bay or through the firewall. Be sure to keep it away from excessive heat. The harness is made up of the following connections: TMAP, IAC, O2, TPS, CTS, fan, tach, injectors, ground, positive connection to the battery, ECU, hand-held controller connection, fuel pump, and key hot.

TMAP (Temperature Manifold Absolute Pressure)

Below - Starting with the TMAP sensor, the TMAP is attached to the outside of the throttle body on the passenger side. It regulates the inlet air temperature and the manifold absolute pressure. The two sensors (inlet air temp and manifold absolute pressure) are combined for ease of installation. The Temperature Manifold Absolute Pressure measures the load on the engine and will range between 10 and 90kPa while the engine is running. When the engine is off it will read at 99-100kPa. See Figure 8 below.

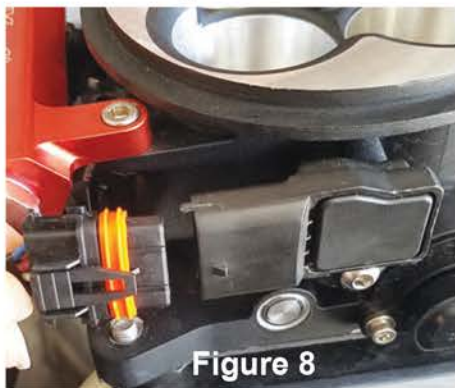

Figure 8

IAC (Idle Air Control)

The Idle Air Control Sensor gets installed directly into the throttle body. It is used to control the RPM of the motor at idle. See Figure 9, above right.

TPS (Throttle Position Sensor)

The Throttle Position Sensor's purpose is to record how far the

throttle blades are open. The ECU maintains the calibration of the sensor but, if the TPS reading is not at 0 at idle then the sensor needs to be recalibrated. See Figure 10.

CTS (Coolant Temp Sensor)

The Coolant Temperature Sensor cable plugs into a supplied sensor fitted into the manifold. It is used to measure the temperature of the engine coolant. The sensor then sends the information to the ECU to adjust fuel. See Figures 11 and 12 on the next page.



Figure 9



Figure 10



Figure 11

Above - The supplied Coolant Temperature Sensor is threaded into the water port in the intake manifold. Use Teflon tape on threads.



Above - The CTS connector on the main wiring harness is plugged into the Coolant Temperature Sensor in the manifold. (1/2" NPT adapter supplied in kit)

Injectors

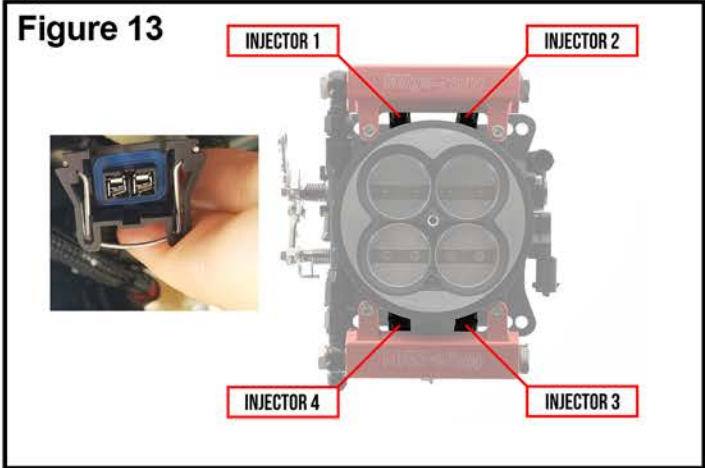

Above - The throttle body has four 66-lb injectors already installed. This arrangement will allow the system to supply enough fuel flow for up to 500 HP. The supplied Wiring Harness has four injector connectors.



See Figure 7. Snap the connectors on the harness onto the individual injectors with the silver wire bar facing down. Make sure the connectors are securely fastened.

Wiring the EFI System

See the wire chart (Figure 16 on page 6) which lists each wire in Harness "A" that is used in the system and what it connects to. NOTE: Typically some of the wires listed in the chart on the next page may need to be extended. It is strongly suggested that any wire extensions are made with the same gauge and color wire as is used in the supplied harness. Make connections as a soldered joint rather than a crimped connection. Utilize a shrink wrapped sleeve covering all connections. All

modifications made to wiring can only be made on wires listed in Wire Chart Figure 16 on the next page such as extensions or cuts. Any modification of the ECU main harness (see Figure 7) other than these listed wires will result in a VOIDING of the Summit warranty.

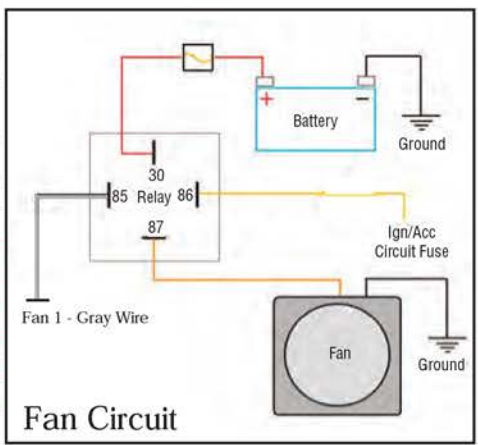





On Engine-Adjustments

When you set idle speed, you will notice some new sounds. The first is ticking from the injectors and it is normal. You may also hear air whooshing or whistling at idle. Barring a vacuum leak, this is likely the bypassed air from the Idle Air Control (IAC valve) and this is normal. The IAC valve maintains idle speed when the AC compressor or electric fans click on.

IAC Setup

The idle screw on the throttle body needs to be adjusted. This needs to be set so that the IAC valve is nearly closed when fully warmed up and in idle 3-10 IAC Steps are recommended for a fully warm engine, out of gear, at idle. When the engine is at idle, the IAC will learn the necessary position to maintain the RPM at the Target Idle Speed. When loads are placed on the engine or when the throttle is open, the IAC steps will move around, this is normal. It's best to adjust this screw from a more open position to start with. This will allow the engine to start at a high idle, which will make adjusting the IAC easier. Follow this procedure:

1. Start the engine and in your Handheld go under "initial set-up."
2. Go to "idle setup" and find "idle set mode" and switch to "Adjust"
3. Start the vehicle and find IAC Steps on the dashboard. This number needs to be within 3-10 at operating temperature. If the number reads zero then slowly turn the screw OUT (counterclock-wise) until the IAC Steps reads between 3-10.

Wire Color	Wires in Wiring Harness Connect to:	Figure 16
Red 	Fuel Pump circuit. This wire provides 12V power to the fuel pump. Connect to the positive (+) terminal on the pump. No relay is required.	
Orange 	Main power on/off. Connect this wire to the ignition switch or other switched 12-volt power source that is hot when key is in the 'On' and 'Crank' (Start) positions and not powered when 'Off'.	
Tan 	Tach input wire which triggers the system. It connects to the negative terminal of the coil. On HEI distributors it connects to the "Tach" terminal on the distributor cap or connects to a tach output on a CDI box.	
Gray 	Fan Circuit #1. This wire goes to the ground (-) terminal of the fan relay. See Figure 15.	

4. If the number is above 10, then turn the screw IN (clockwise) as stated above and repeat the process until the IAC steps are between 3-10.

5. When finished turn key off and allow system to save (30 seconds of key off), and the system will automatically shut off idle set mode

NOTE: Once the IAC set up is complete no further adjustments are necessary

Handheld Controller

There are two ways to navigate the Handheld Controller; you can use the touchscreen with your finger or the joystick: up, down, left, and right. The joystick is the black button on the right hand side of your controller, it can be used to view the displays on the Controller by moving the button up and down or side to side, then pressing the joystick = enter.

1. When making changes to the ECU through the Handheld Controller, make sure that the ignition key is on.

2. Once the changes are made, turn the key off, wait 15 to 20 seconds until the values disappear under the "dashboard" feature. Doing this will ensure that your changes have received a hard save.

3. Once the hard save is completed, if desired, the vehicle battery can be disconnected without interference with the calibrations.

Initial Programming

This simple procedure is performed using the Handheld Controller. A laptop computer is not required.

* This unit plugs into the throttle body ECU

* Input the number of cylinders, cubic inch displacement, cam size, target idle speed warm, fan control, RPM limit and max rev limit.

* The Handheld Controller can be removed or left connected. When connected, there is a dashboard and gauges screen that will show engine parameters in real time. Included in your kit is a windshield or dash mounted bracket to hold the controller while driving.

(Note: When changing values on the Handheld Controller, you must depress the joystick button to send your info to the ECU. You will then see 'Sent to ECU Succeed' message which is a confirmation that it was successful (Changing the number alone will not change the value in the ECU). Also, all items have a factory default which may work for you – change only as needed!

1. Cylinders - Factory preset is 8 and shouldn't need to be changed for most installations.

2. Engine CID – Factory preset is 350 CID. To change value you can use touchscreen buttons (Edit, CLR value from screen, Enter your number now, press OK, then depress joystick button to enter). Sent and Succeed message will appear. This entire step can also be performed using the joystick.

3. Cam Mild-Wild – Cam selection is based on vacuum load of the engine. Choose the selection that corresponds with the amount of manifold vacuum your engine produces at idle (in Neutral). Cam 1 is for 15inHg or above, Cam 2 is for 10inHg to 15inHg, Cam 3 is 8inHg to 10inHg, Cam 4 is 6inHg to 8inHg. These are estimates and you may need to switch between them if the vacuum load is between two different cam settings to get the engine to run better for your application.

4. Rev limit RPM – This is a fuel cut. Please set at least 200 RPM above the maximum RPM you wish your engine to run to. This is not a soft touch rev limiter, but a built-in safety feature.

5. Idle Speed Warm – The idle speed at which you wish your engine to run at 150 degrees and above. If you are using the MAX-efi500 to control your electric fans, your idle speed will increase by 30 rpm, will be higher when the engine is colder and will taper down to set speed by 150 degrees.

Fan 1 Setup

On the Calibration screen, follow these steps:

If using an electric fan, go to option # 3 and select Enable , then press Enter or depress the joystick button to send info to the ECU. If not using an electric fan, select Disable and continue the Enter/Send steps above
Note: This step is important to eliminate a fault code from appearing when not using an electric fan, and also eliminating the idle speed from increasing when the fan "ON" temperature is achieved and no fan is used. If fan is enabled, follow these next steps:

#1) Fan 1 ON Temp - Enter desired temperature, Enter/ depress to send to ECU. Idle speed will increase when fan is activated. Idle speed increase is not user programmable in basic calibration.

#2) Fan 1 OFF Temp - This is usually set approximately 5 degrees lower than Fan ON temperature, but is up to user preference. Note: Setting must be lower than fan ON temperature for fans to shut off.

At this point you have made all of the selections you need to start your engine! BUT WAIT!!!!. Please turn your key to the OFF POSITION and wait for about 30 seconds for the ECU to store these changes. This is a one-time setup and the changes are permanently stored in the ECU even if you disconnect the battery! They can be changed at any time in the future but no battery power is needed for the ECU to keep these selections in its memory.

Fuel Delivery Requirements

Note: Before starting any installation, disconnect the ground connection on the battery. Be very careful when disconnecting any fuel lines and let the fuel drain into a receptacle or a dry cloth. Do not allow raw fuel to collect on the engine as this is a fire hazard. Please observe extreme caution when working with the fuel system. The MAX-efi500 is an unregulated system that comes with a fuel crossover hose installed. An external regulator must be used to ensure that the throttle body receives the proper 58psi. When plumbing the MAX-efi500 run a fuel line from the tank through your fuel delivery system then to the crossover hose (-6AN) . (See Figure 17) If you are using a regulated fuel delivery system then an external regulator is not necessary. If the fuel delivery system does not have a regulator, an external regulator must be installed after the filter.

The MAX-efi500 is not compatible with a low pressure carbureted style pump, it requires a high pressure fuel injection pump. It is also important to make sure that the system uses a 10-40 micron filter.

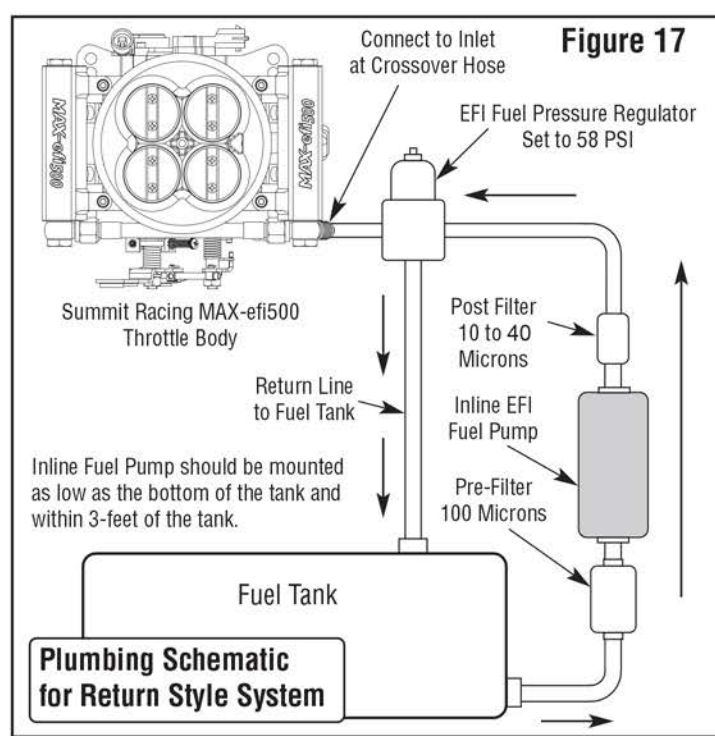

Selecting the correct wiring schematic: Review Figures 18 through 20 and select the schematic that suits your particular application. Figure 18 shows how to connect a ready-to-run distributor. Figure 19 is for an HEI distributor. Figure 20 is for a system with an external CDI box. One of these configurations will suit your vehicle.

Connections for Summit EFI System with Ready-To-Run Distributor

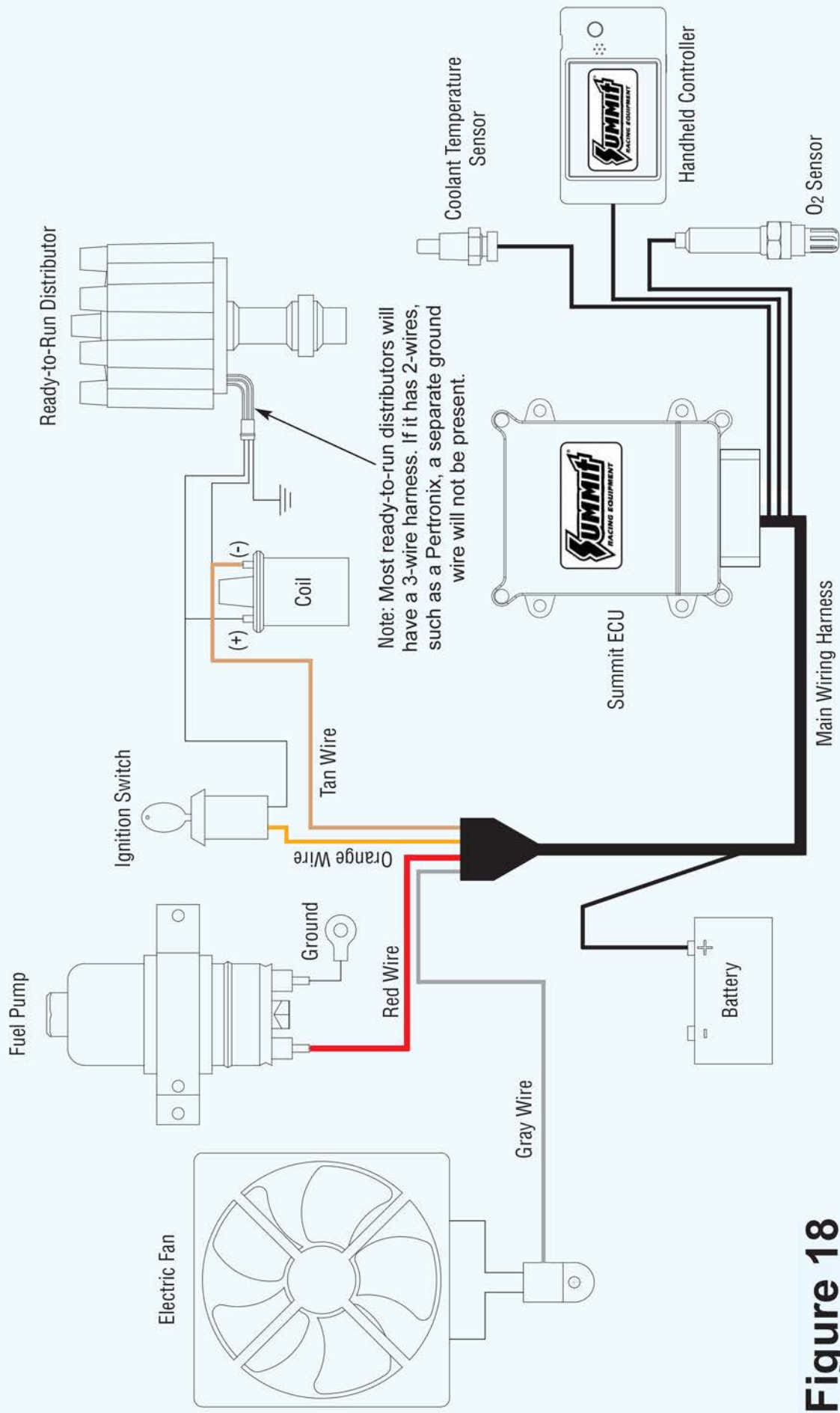

Figure 18

Wiring Connections for Summit EFI System with HEI Distributor

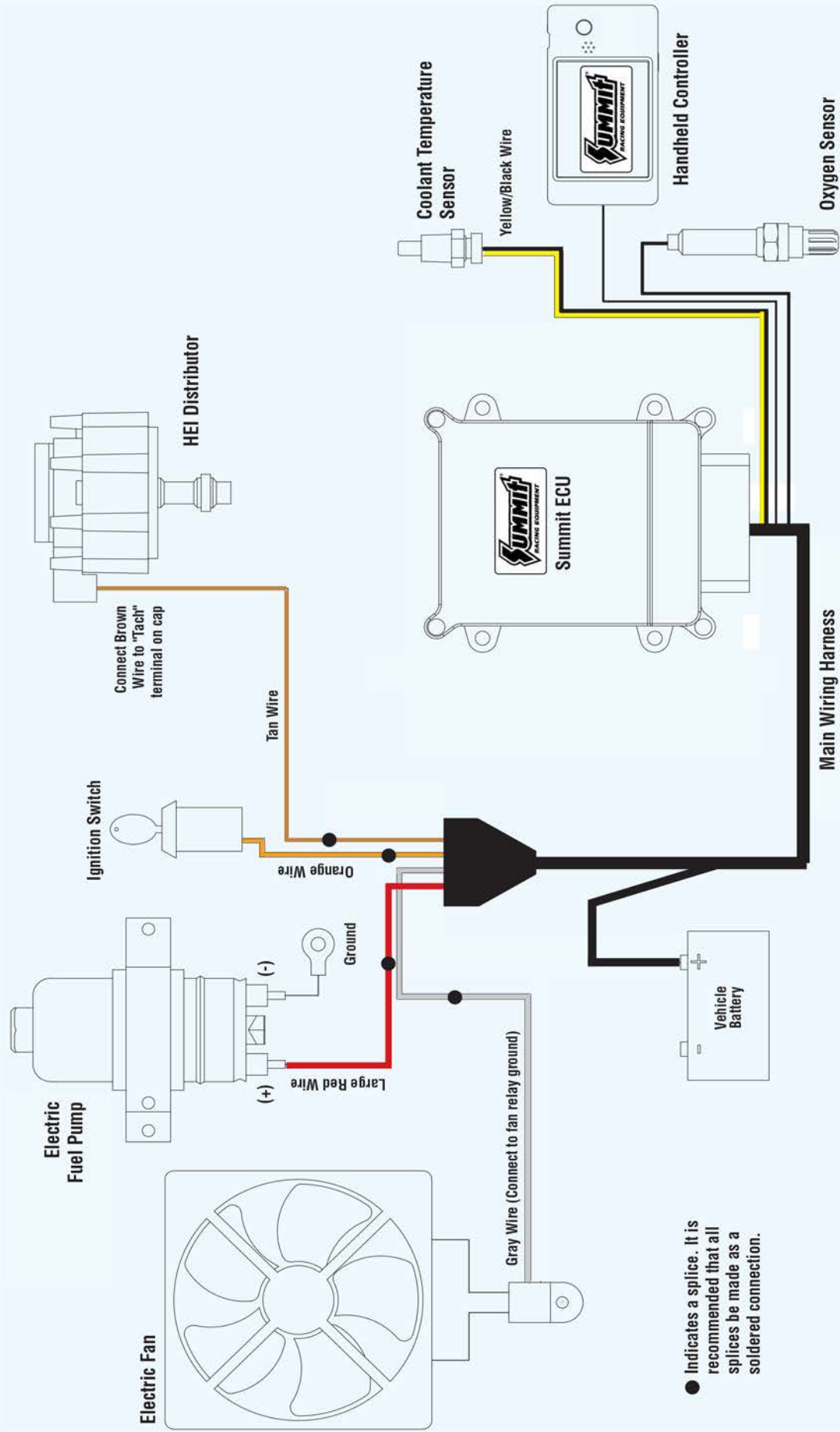

Figure 19

Use this wiring schematic if you are utilizing an HEI distributor without an external CDI box, such as a MSD 6AL or similar aftermarket ignition box.

Wiring Connections for Summit EFI System with External CDI Box

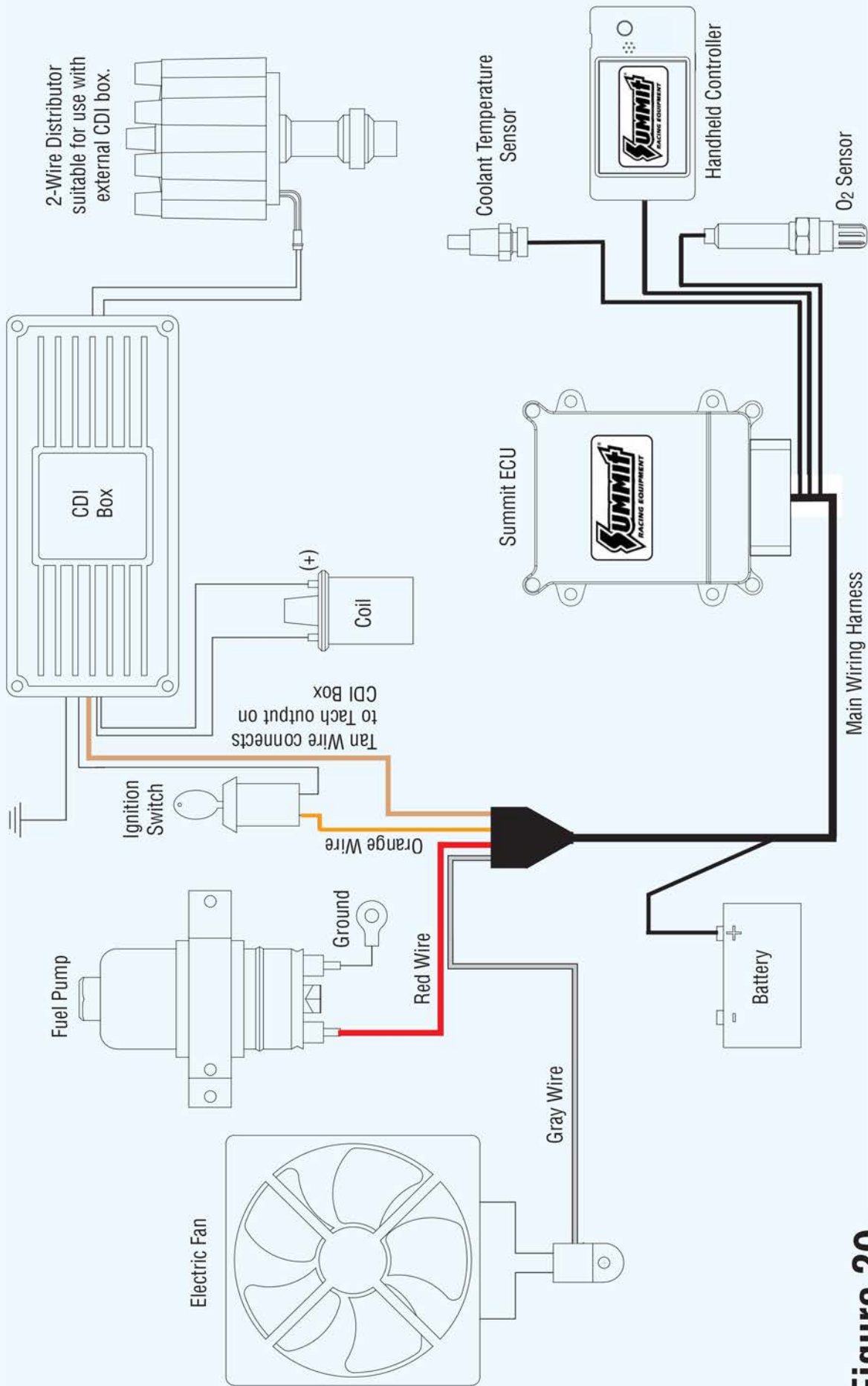

Figure 20

Use this wiring schematic if you are utilizing a conventional two-wire distributor with an external CDI box, such as a MSD 6AL or similar aftermarket Capacitive Discharge Ignition (CDI) box.